



User Manual

www.doughty-usa.com

T57120/21 Doughty Easy Grip Clamp



Version 01/11



www.doughty-usa.com

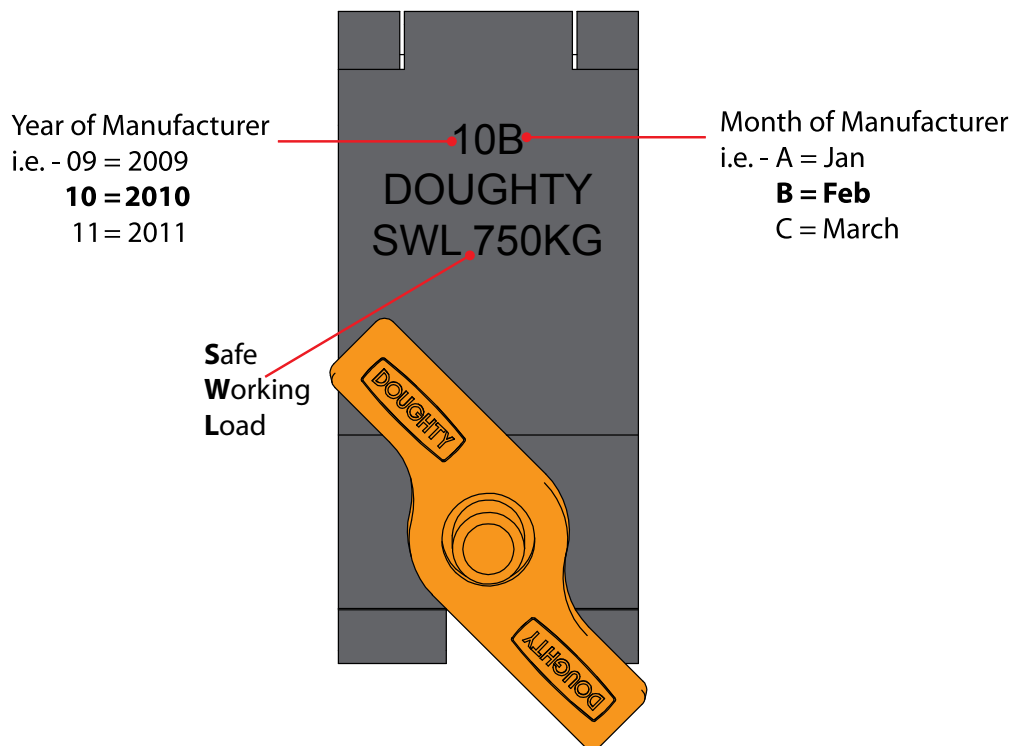
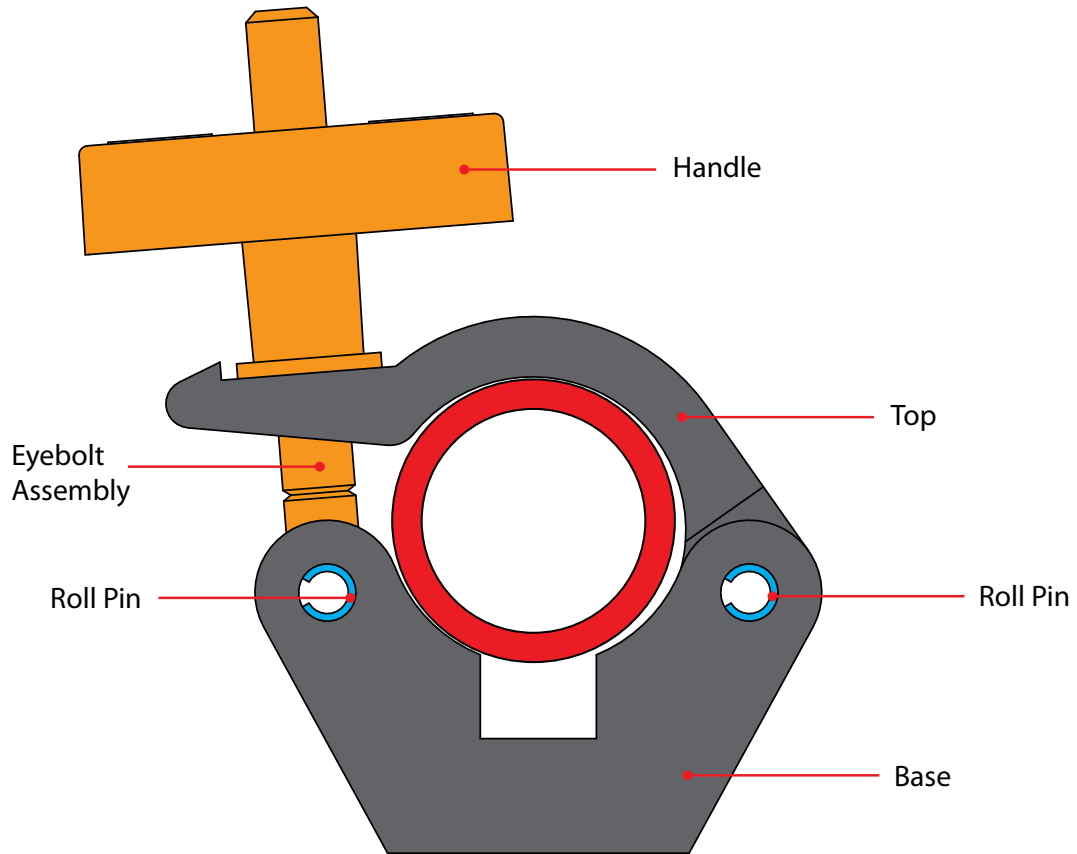

1. Never exceed the Safe Working Load (SWL) shown on the clamp.
2. Only use the clamp within the designed tube parameters (2")
3. All clamps should be visually inspected before use. In the event of any damage the clamp should be taken out of service and returned to an 'Approved Doughty Service Agent' for inspection. (see our dealer locator on our web site for a comprehensive list of Authorised Service Agents)
4. When used in conjunction with other accessories, care must be taken to ensure that the minimum SWL of any component is not exceeded.
5. Doughty Engineering Ltd does not recommend using any clamps which do not fully encompass the tube for overhanging. All open clamps including hookclamps should be used in a vertical orientation only.

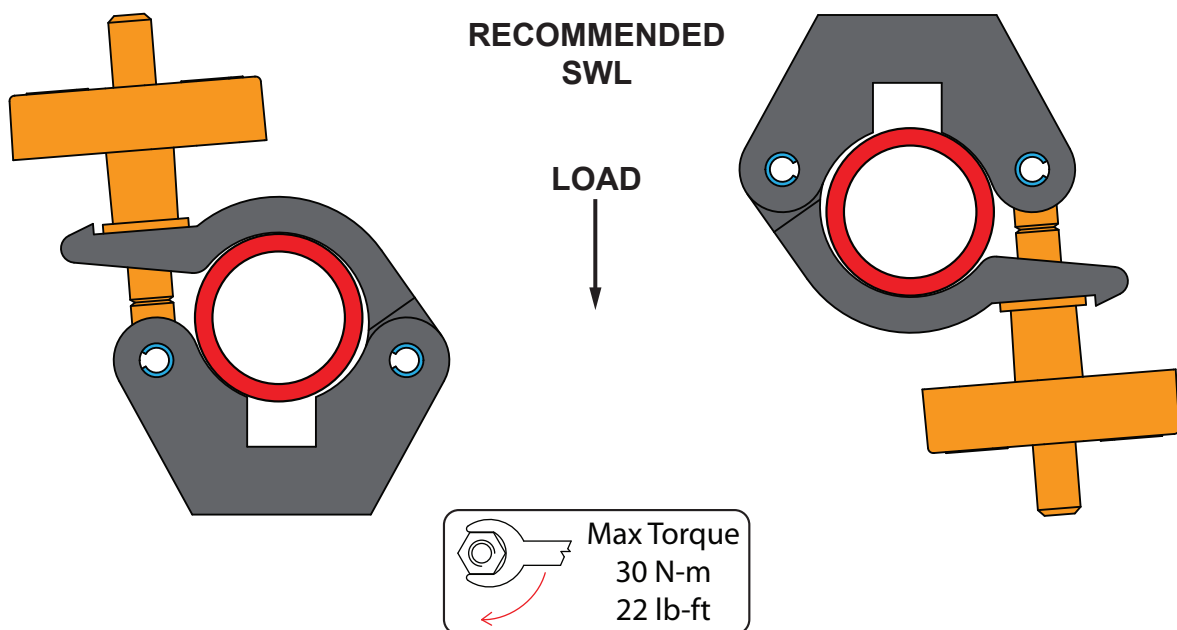

THE FOLLOWING APPLICATIONS WILL RESULT IN THE RECOMMENDED SWL BEING REDUCED DEPENDANT ON THE TUBE SURFACE FINISH & TORQUE SETTINGS APPLIED. PROOF LOADING ON INSTALLATIONS IS RECOMMENDED.

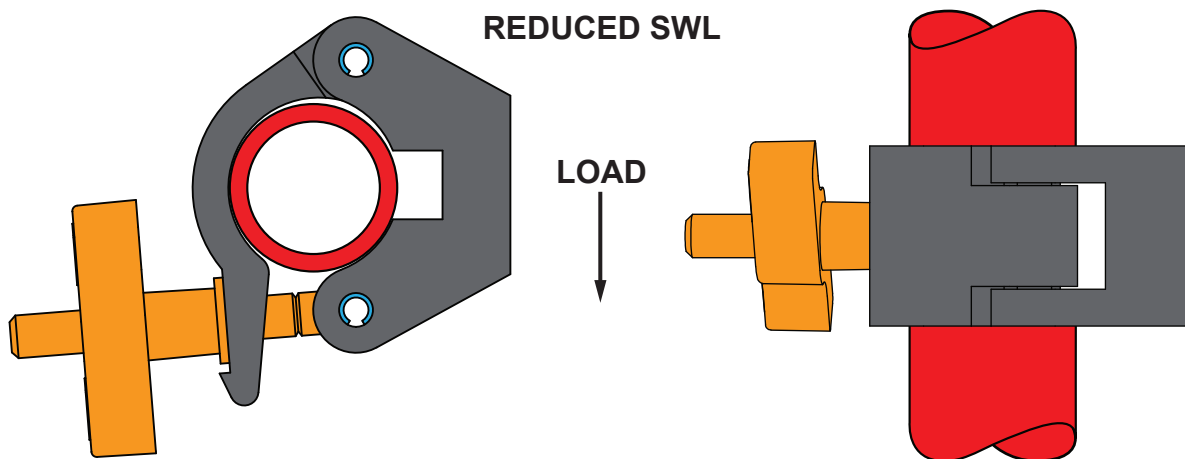



DOUGHTY ENGINEERING LTD

DATA SHEET

TITLE:
DOUGHTY CLAMP
EASY GRIP

PART NOS:
T57120 - POLISHED
T57121 - BLACK

MATERIAL :
ALUMINIUM

WEIGHT:
1.38 lbs

SWL:
1.653 lbs

FINISH:

NOTES:

MIN TUBE SIZE - 1.89"
MAX TUBE SIZE - 2"

**STRICTLY
FOR
REFERENCE
PURPOSES
ONLY**



THIRD ANGLE PROJECTION

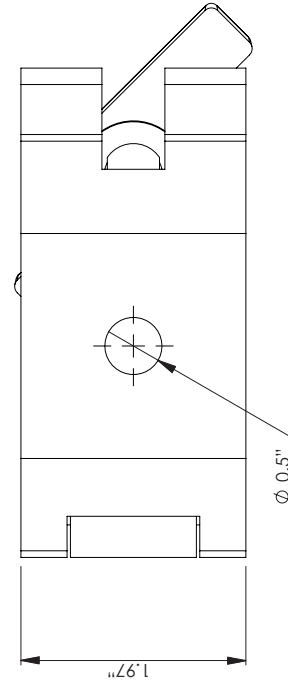
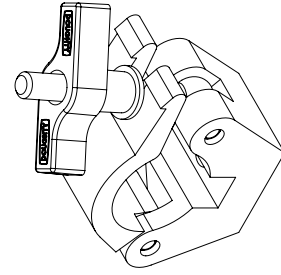
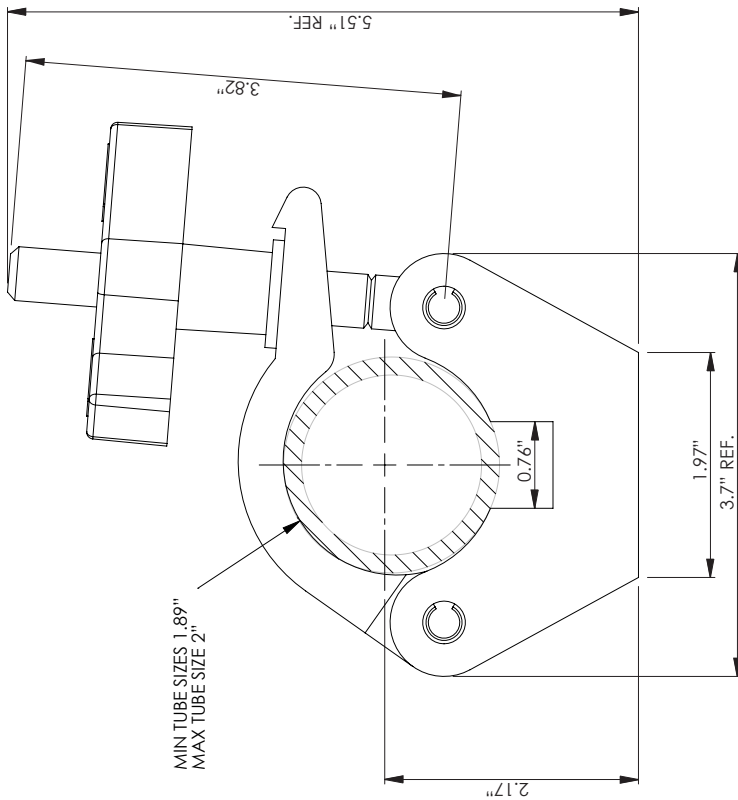
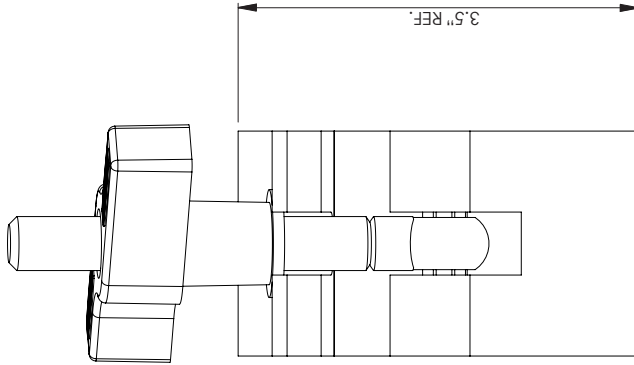

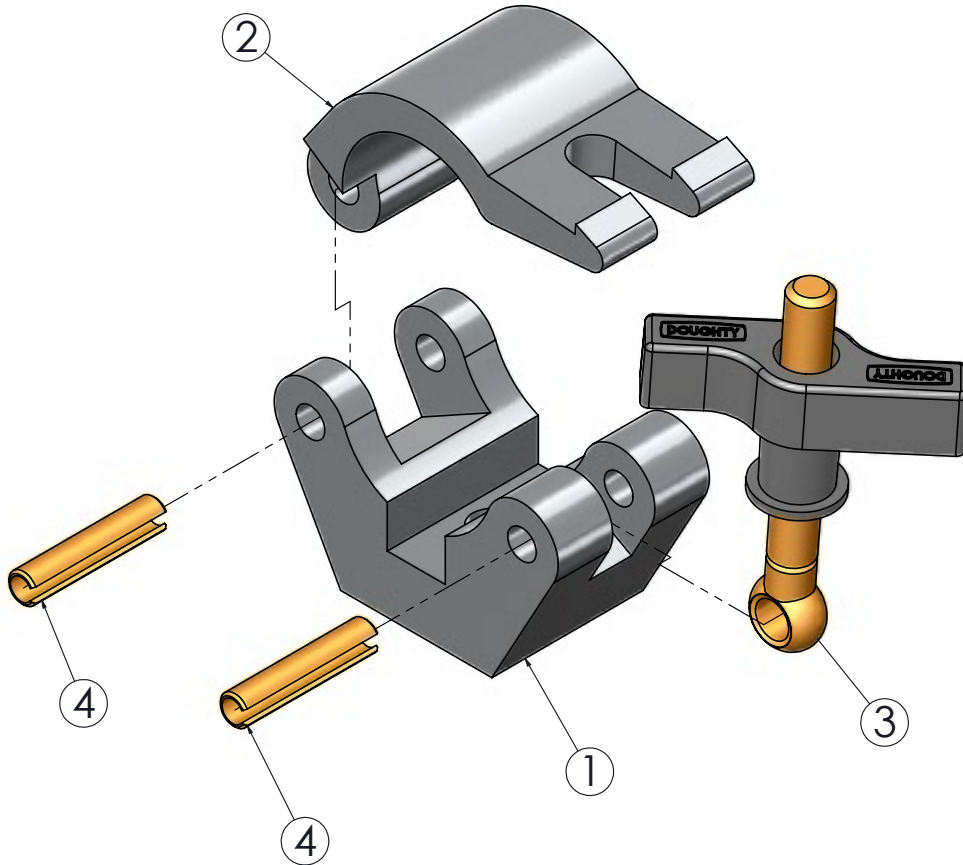

DOUGHTY PRODUCTS MUST ONLY BE SERVICED / REPAIRED BY
 AN AUTHORISED SERVICE AGENT.
 SPARE PARTS ARE ONLY AVAILABLE TO THESE AGENTS

ITEM NO.	PART NUMBER	DESCRIPTION	Spares/QTY.
1	TH156	MACHINED DOUGHTY CLAMP BASE	1
2	TH157	MACHINED DOUGHTY CLAMP TOP	1
3	T78052	M12 X 104 EYEBOLT ASSEMBLY	1
4	F790	0.375" X 1.75" STAINLESS STEEL ROLL PIN	2

**T57120 - DOUGHTY CLAMP
 - EASY GRIP**



DRAWN	AW
DATE	04/01/2011
Rev	1

NOT TO SCALE



Doughty Engineering Limited

CROW ARCH LANE, RINGWOOD, HANTS, BH24 1NZ. ENGLAND
Telephone: +44 (0) 1425 478961 Fax: +44 (0) 1425 474481
www.doughty-engineering.co.uk
email:sales@doughty-engineering.co.uk

EC DECLARATION OF CONFORMITY

Doughty Engineering Limited hereby certify that the equipment stated below has been designed to comply with all relevant sections of the specifications referenced below and complies with all the applicable Essential Requirements of the EC Directives and amendments and the National Laws and Regulations adopting these Directives.

Description: Doughty Easy Grip Clamp

Model/s: Part No. T57120 / T57121

SWL: 750Kg **Factor:** 5:1

are in conformity with the provision of the following EC Directives:

MACHINERY DIRECTIVE 98/37/EC

Harmonised Standards applied:

EN 292-1-2:1991

BS EN ISO 9001:1994

National Technical Standards & Specifications applied:

BS 7905-1:2001

Signed:  Date:23-04-08

Name: Nigel Curtis Position: Technical Director

Being the responsible person appointed by the manufacturer.



DEQ 083 Rev 4

Company Registration No. London 972614
Registered Office: Crow Arch Lane, Ringwood, Hants, BH24 1NZ
Directors: M.B.Lister. J.C.G. Chiverton. N.D. Curtis. S.C. Wright





Doughty Engineering USA

401 So. Mount Juliet Road
Suite #235/145
Mount Juliet
TN. 37122

Ph: (615) 470-5255 Fx: (615) 470-5389

email: doughtyusa@gmail.com

Web: www.doughty-usa.com

Note: Whilst every effort has been made to ensure that the information contained within this manual is correct, Doughty Engineering does not accept any liability for errors or omissions. Specifications and technical data are intended for guidance purposes only and may vary.