

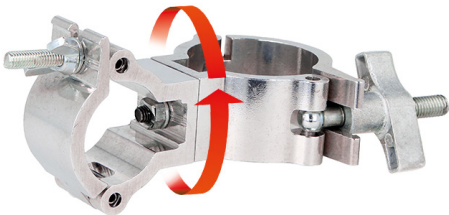

Product Data Sheet

Super Lightweight to Atom Coupler



A super lightweight half coupler and 35mm (1.38") atom coupler	
Part Nos	T58134 - Polished T5813401 - Powder Painted Satin Black
Tube Diameter	Ø48 - 51mm (1.89" - 2.01") & Ø35mm (1.38")
Materials	Main Body - AW6082 T6 Aluminium Roll Pins - Stainless Steel Eyebolt - Grade 8.8
Max Tightening Torque	Hand-tight Only
Fixings	N/A
WLL	100Kg
Weight	0.29Kg (0.64 lbs)
Factor of Safety	5:1
Approval	TÜV Approved

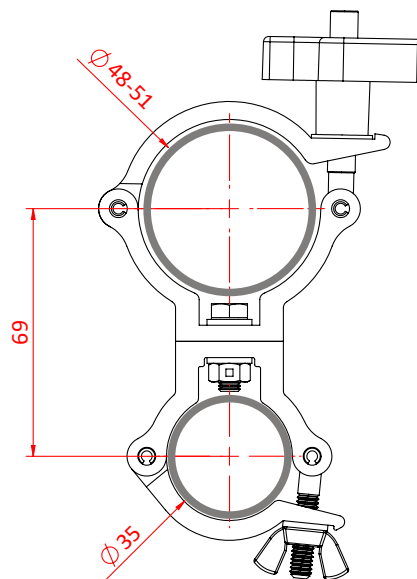
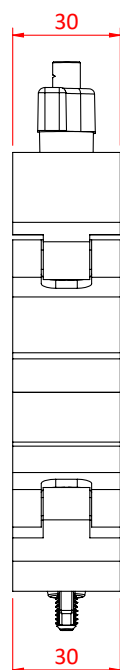

Dimensions in mm