



Product Data Sheet

# Speedrail Angled Cross 30-45



A magnesium alloy pipe fitting.	
<b>Part Nos</b>	T194021-45
<b>Tube Diameter</b>	Ø48.3mm
<b>Materials</b>	Magnesium Alloy 535 Fixings - Grade 8.8 BZP
<b>Max Tightening Torque</b>	22Nm
<b>WLL</b>	N/A
<b>Weight</b>	0.25Kg

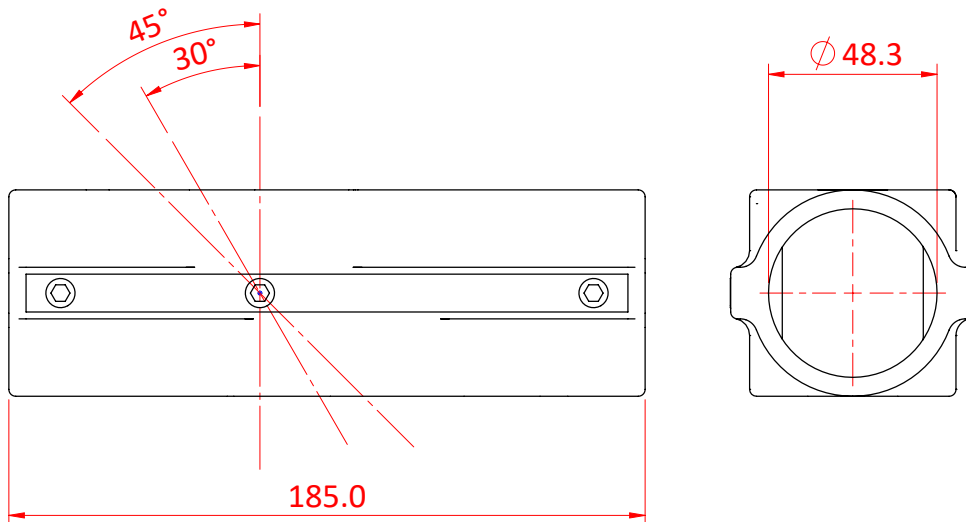

DIMENSIONS ARE A GUIDE ONLY AND MAY VARY

Doughty Engineering Ltd - Crow Arch Lane, Ringwood, Hampshire, BH24 1NZ, UK  
+44 (0) 1425 478961, sales@doughty-engineering.co.uk - www.doughty-engineering.co.uk